

SASH LIFTS

150

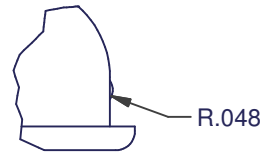

DETAIL A

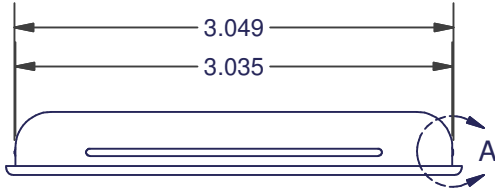
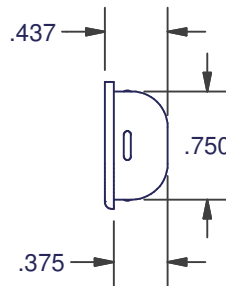
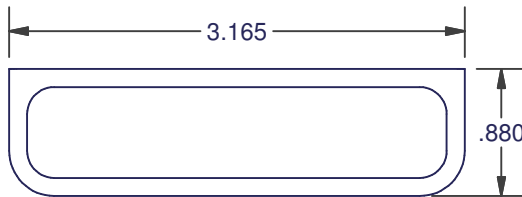
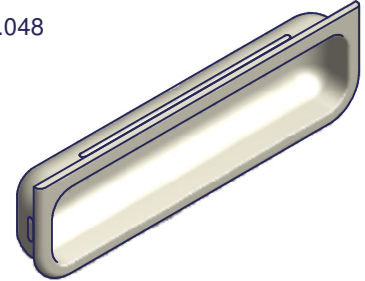

MATERIAL: NYLON

| ITEM | COLOR |
|-------|-------|
| 150-1 | WHITE |
| 150-4 | TAN |

163

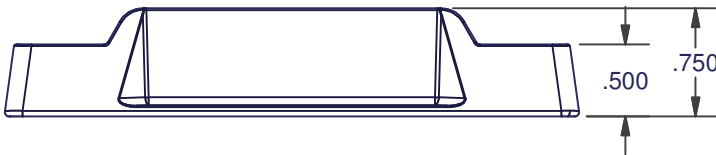
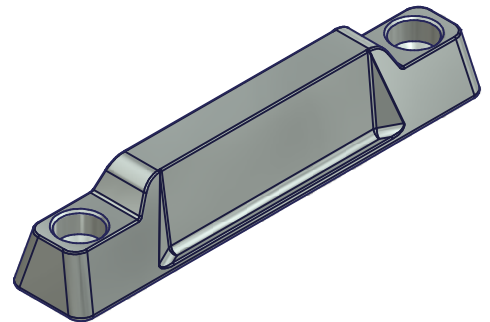
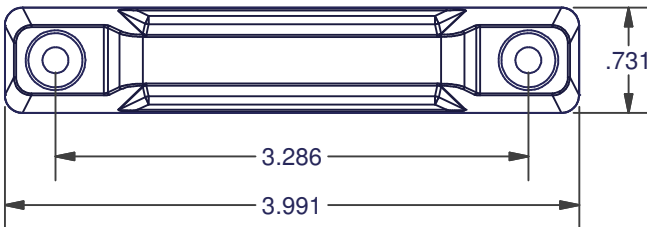

MATERIAL: ABS

| ITEM | COLOR |
|-------|------------|
| 163-1 | WHITE |
| 163-4 | BEIGE |
| 163-7 | DARK BROWN |

DIMENSIONS ARE FOR REFERENCE ONLY AND ARE IN INCHES UNLESS OTHERWISE NOTED.
 CONTACT OUR ENGINEERING DEPARTMENT WITH SPECIFIC APPLICATION QUESTIONS OR REQUIREMENTS.
 NOT ALL COMBINATIONS LISTED ARE CURRENTLY STOCKED, EXTRA LEAD TIME MAY BE REQUIRED.