

SLIDING DOOR KEEPERS

2264 SERIES
SINGLE POINT
 BOX QTY: 50

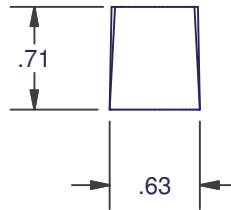
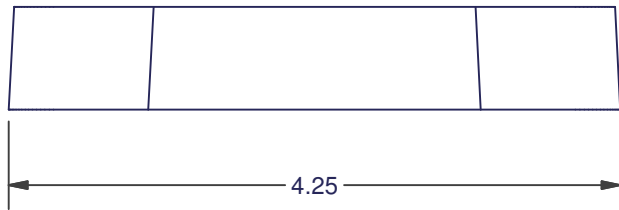
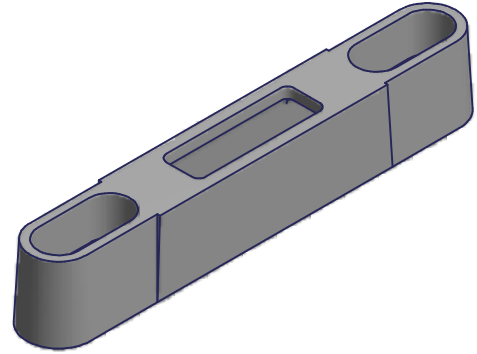
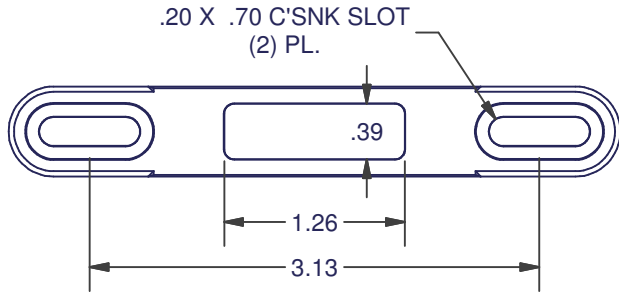

KEEPER & INSTALLATION SCREWS	
MATERIAL	ITEM #
ZINC	ADH-3018-00

KEEPER ONLY	
MATERIAL	ITEM #
ZINC	2264-00

2315 SERIES
SINGLE POINT
 BOX QTY: 50

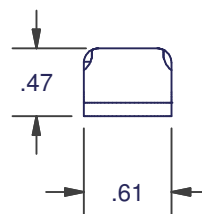
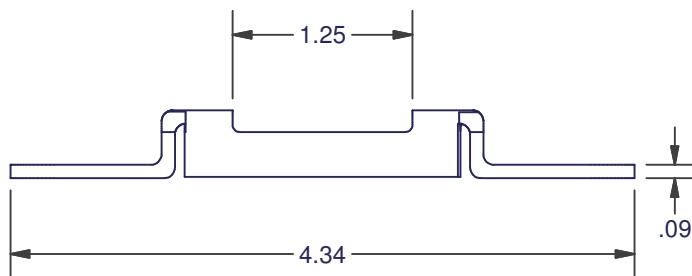
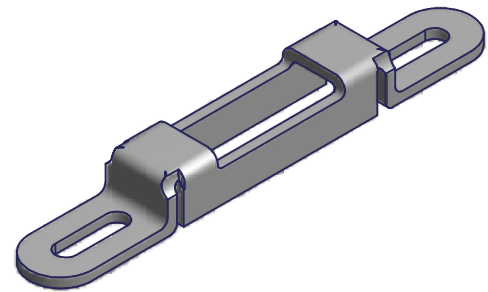
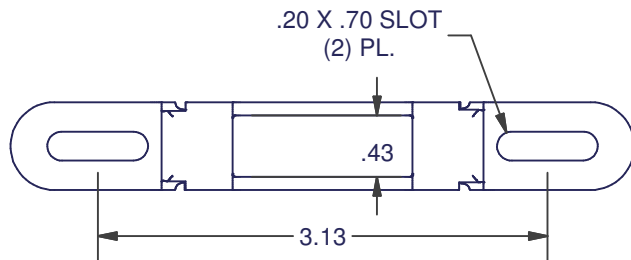

KEEPER & INSTALLATION SCREWS	
MATERIAL	ITEM #
STEEL	ADH-3014-00
STAINLESS STEEL	ADH-3014-84

KEEPER ONLY	
MATERIAL	ITEM #
STEEL	2315-00
STAINLESS STEEL	2315-84

DIMENSIONS ARE FOR REFERENCE ONLY AND ARE IN INCHES UNLESS OTHERWISE NOTED.
 CONTACT OUR ENGINEERING DEPARTMENT WITH SPECIFIC APPLICATION QUESTIONS OR REQUIREMENTS.
 NOT ALL COMBINATIONS LISTED ARE CURRENTLY STOCKED, EXTRA LEAD TIME MAY BE REQUIRED.