

SLIDING DOOR KEEPERS

2470 SERIES
MULTI POINT
 BOX QTY: 50

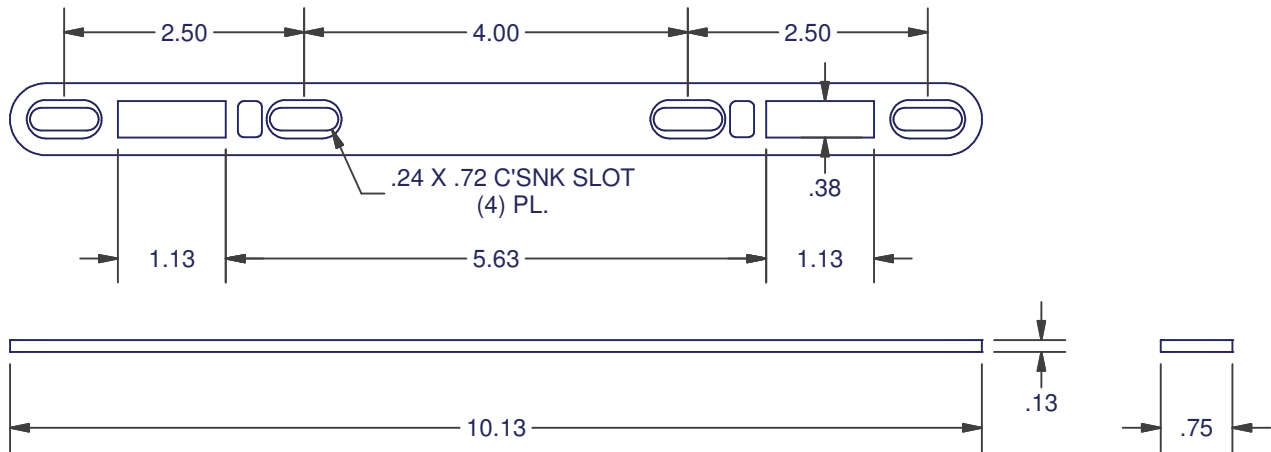
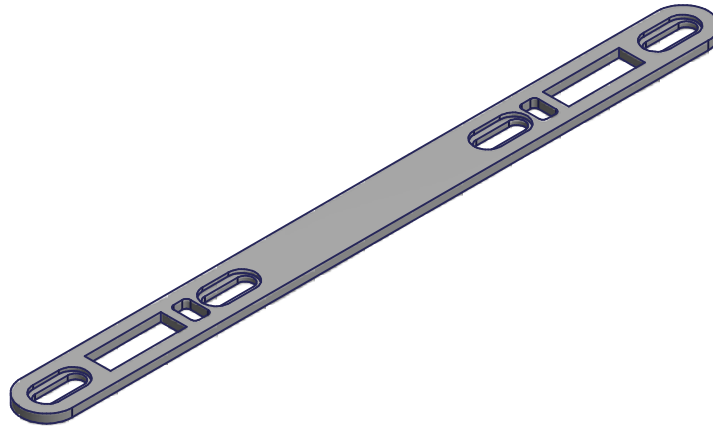

KEEPER & INSTALLATION SCREWS	
MATERIAL	ITEM #
STEEL	ADH-3021-00
STAINLESS STEEL	ADH-3021-84

KEEPER ONLY	
MATERIAL	ITEM #
STEEL	2470-00
STAINLESS STEEL	2470-84

DIMENSIONS ARE FOR REFERENCE ONLY AND ARE IN INCHES UNLESS OTHERWISE NOTED.
 CONTACT OUR ENGINEERING DEPARTMENT WITH SPECIFIC APPLICATION QUESTIONS OR REQUIREMENTS.
 NOT ALL COMBINATIONS LISTED ARE CURRENTLY STOCKED, EXTRA LEAD TIME MAY BE REQUIRED.