

SLIDING DOOR KEEPERS

3221 SERIES
MULTI POINT
 BOX QTY: 50

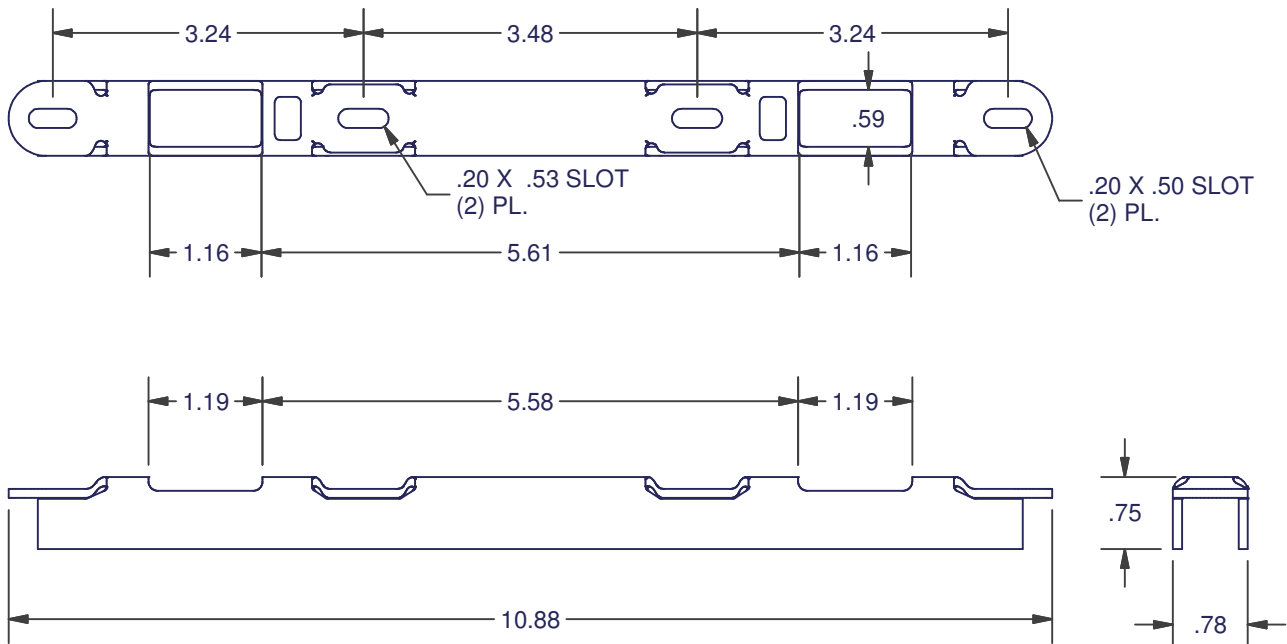
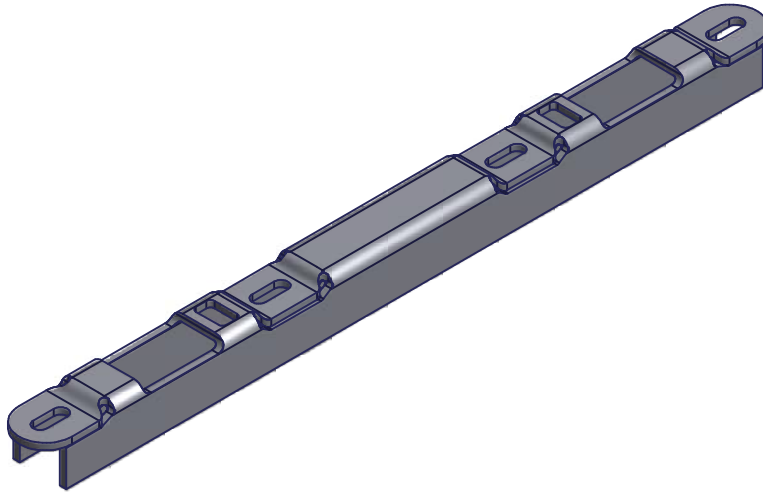

KEEPER ONLY	
MATERIAL	ITEM #
STAINLESS STEEL	3221-84

DIMENSIONS ARE FOR REFERENCE ONLY AND ARE IN INCHES UNLESS OTHERWISE NOTED.
 CONTACT OUR ENGINEERING DEPARTMENT WITH SPECIFIC APPLICATION QUESTIONS OR REQUIREMENTS.
 NOT ALL COMBINATIONS LISTED ARE CURRENTLY STOCKED, EXTRA LEAD TIME MAY BE REQUIRED.