

TILT LATCHES

10237 SERIES TILT LATCH ASSEMBLIES

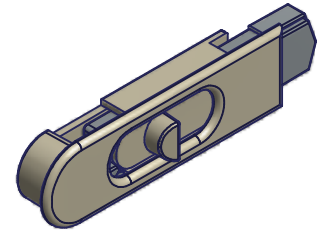
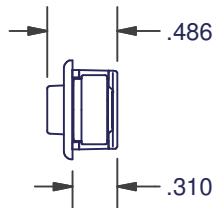
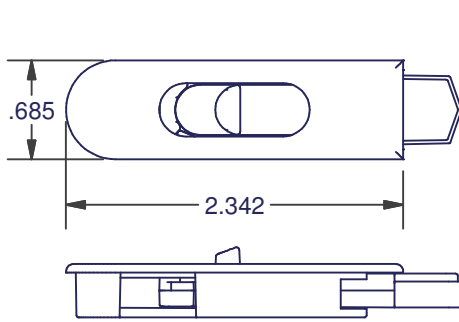

HOUSING W/ FINGER PULL

(10237-12-UNI ASSEMBLY SHOWN)
WSD WHITE SHOWN

MATERIAL:
HOUSING = ZINC
FINGER PULL = ZINC
INSERTS = GF NYLON

NUMBERING SCHEME EXAMPLE 10237-12-4-R

SERIES	COLOR	BOLT STYLE	HAND
10237	12	4	R

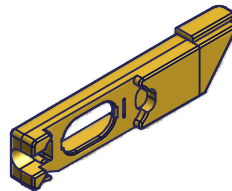
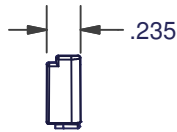
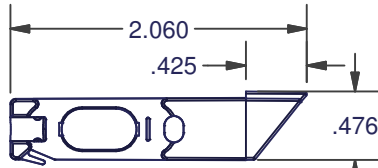

#2 INSERT, RIGHT HAND SHOWN

SEE CHART ON PAGE 3 FOR MORE INFO

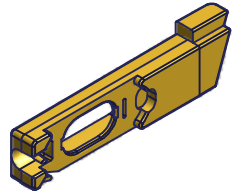
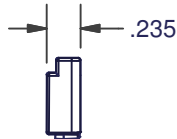
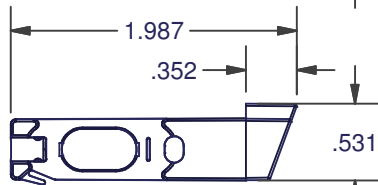

#3 INSERT, RIGHT HAND SHOWN

SEE CHART ON PAGE 3 FOR MORE INFO

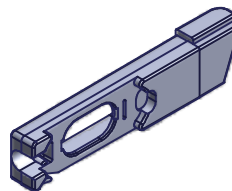
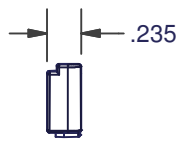
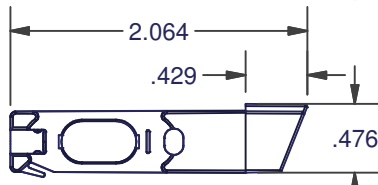

#4 INSERT, RIGHT HAND SHOWN

SEE CHART ON PAGE 3 FOR MORE INFO

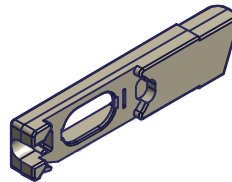
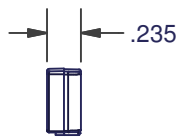
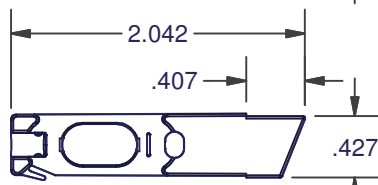

#BTM INSERT, RIGHT HAND SHOWN

SEE CHART ON PAGE 3 FOR MORE INFO

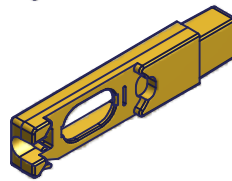
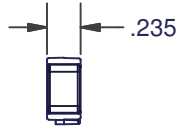
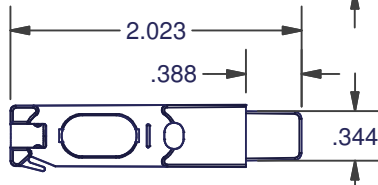

#9 INSERT, UNIVERSAL

SEE CHART ON PAGE 3 FOR MORE INFO

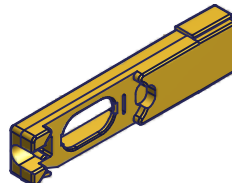
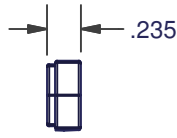
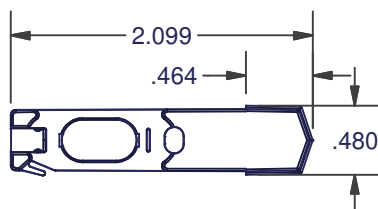

UNI INSERT, UNIVERSAL

SEE CHART ON PAGE 3 FOR MORE INFO

DIMENSIONS ARE FOR REFERENCE ONLY AND ARE IN INCHES UNLESS OTHERWISE NOTED.
CONTACT OUR ENGINEERING DEPARTMENT WITH SPECIFIC APPLICATION QUESTIONS OR REQUIREMENTS.
NOT ALL COMBINATIONS LISTED ARE CURRENTLY STOCKED, EXTRA LEAD TIME MAY BE REQUIRED.

