

WINDOW ROLLERS

142 SERIES

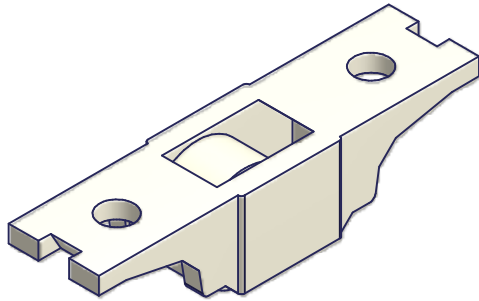

STD HOUSING

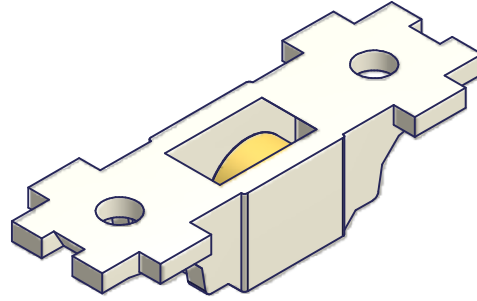

TAB HOUSING

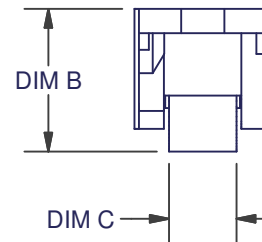
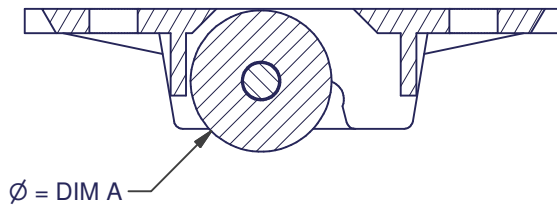
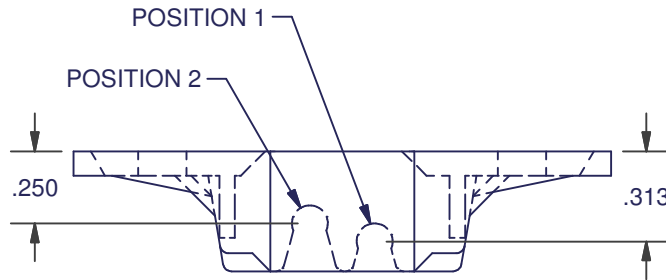
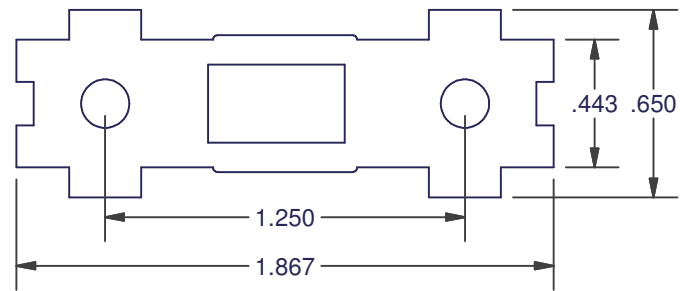
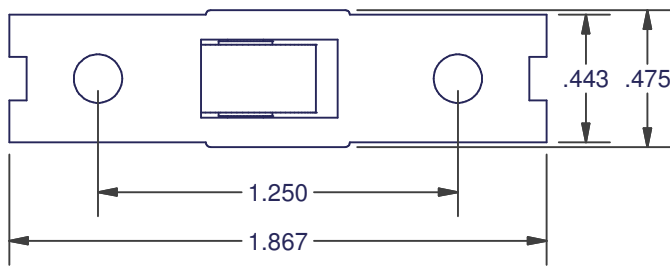

AMESBURY ITEM #	REFERENCE ITEM #	HOUSING	ROLLER POSITION	DIM A	DIM B	DIM C	MATERIAL		
							HOUSING	ROLLER	AXLE
400141	142-142-R-HS	STD	1	\varnothing .490	0.495	0.235	NYLON NATURAL	CELCON NATURAL	BRASS
400190	142-142-R-LS	STD	2	\varnothing .490	0.495	0.235	NYLON NATURAL	CELCON NATURAL	BRASS
400142	142-143-8-HS	STD	1	\varnothing .404	0.452	0.225	NYLON NATURAL	CELCON NATURAL	BRASS
400191	142-143-8-LS	STD	2	\varnothing .404	0.452	0.225	NYLON NATURAL	CELCON NATURAL	BRASS
400143	142-8-1BW-HS	STD	2	\varnothing .404	0.452	0.225	NYLON NATURAL	BRASS	INTEGRAL TO ROLLER
400192	142-8-1BW-LS	STD	1	\varnothing .404	0.452	0.225	NYLON NATURAL	BRASS	INTEGRAL TO ROLLER
400144	142-8-HS	TAB	1	\varnothing .404	0.452	0.215	NYLON NATURAL	BRASS	INTEGRAL TO ROLLER
400193	142-8-LS	TAB	2	\varnothing .404	0.452	0.215	NYLON NATURAL	BRASS	INTEGRAL TO ROLLER

DIMENSIONS ARE FOR REFERENCE ONLY AND ARE IN INCHES UNLESS OTHERWISE NOTED.
 CONTACT OUR ENGINEERING DEPARTMENT WITH SPECIFIC APPLICATION QUESTIONS OR REQUIREMENTS.
 NOT ALL COMBINATIONS LISTED ARE CURRENTLY STOCKED, EXTRA LEAD TIME MAY BE REQUIRED.